

USER MANUAL

G-MASTER

LCD Monitor

ENGLISH

G-MASTER ***GB2888UHSU***

Thank you very much for choosing the iiyama LCD monitor. We recommend that you take a few minutes to read carefully through this brief but comprehensive manual before installing and switching on the monitor. Please keep this manual in a safe place for your future reference.



Dear user, we congratulate you on the purchase of your iiyama LCD.

For details on warranty and locally used pixel policies that apply directly after installation of your product please check the iiyama website.

To report a fault, please contact your local support centre found at www.iiyama.com/service

Things to check before you call the iiyama information line

- | if the power cable is connected securely and turned on?
- | if the display has been turned on?
- | if the signal cable is connected securely and the correct input selected?
- | if the computer has been restarted with the display connected?
- | if the graphics card is correctly installed with the latest drivers possible?
- | if the correct native resolution has been selected via 'Display Properties'?
- | If the R/G/B signal configuration is correct?
- | if the displays On Screen Menu is shown?
- | if the correct brightness and contrast settings have been set?
- | if given display tolerances and compatibility have been considered?
- | if via the On Screen Menu you have performed a Factory Reset/Recall?

Before reporting the screen defect, please prepare the following information/evidence:

- | model number *
- | purchase receipt and serial number *
- | name and address for collection
- | telephone/fax number, for availability during the day
- | convenient collection date (date, time)
- | short description of the defect

Important Note:

If there is no fault found in the collected equipment after inspection, the transferring party shall incur charges for transport and administration.

If you have checked all of the above and there is still no picture, call our information line for assistance in your country.

* see the identification plate on the back of the case.

CE MARKING DECLARATION OF CONFORMITY

This LCD monitor complies with the requirements of the EC/EU Directive 2014/30/EU "EMC Directive", 2014/35/EU "Low Voltage Directive", 2009/125/EC "ErP Directive" and 2011/65/EU "RoHS Directive".

The electro-magnetic susceptibility has been chosen at a level that gives correct operation in residential areas, business and light industrial premises and small-scale enterprises, inside as well as outside of the buildings. All places of operation are characterised by their connection to the public low voltage power supply system.

IYAMA CORPORATION: Wijkmeerstraat 8, 2131 HA Hoofddorp, The Netherlands

Model No. : PL2888UH



We recommend recycling of used product. Please contact your dealer or iiyama service center. Recycle information is obtained via the Internet, using the address:
<http://www.iiyama.com>

You can access the Web page of different countries from there.

- We reserve the right to change specifications without notice.
- All trademarks used in this user manual are the property of their respective owners.

TABLE OF CONTENTS

FOR YOUR SAFETY.....	1
SAFETY PRECAUTIONS.....	1
SPECIAL NOTES ON LCD MONITORS.....	3
CUSTOMER SERVICE.....	3
CLEANING.....	3
BEFORE YOU OPERATE THE MONITOR.....	4
FEATURES.....	4
CHECKING THE CONTENTS OF THE PACKAGE.....	4
WALL MOUNTING.....	5
FITTING AND REMOVAL OF BASE.....	6
CONTROLS AND CONNECTORS.....	7
CONNECTING YOUR MONITOR.....	8
COMPUTER SETTING.....	9
ADJUSTING THE HEIGHT AND THE VIEWING ANGLE.....	9
OPERATING THE MONITOR.....	10
ADJUSTMENT MENU CONTENTS.....	12
SCREEN ADJUSTMENTS.....	21
POWER MANAGEMENT FEATURE.....	24
TROUBLE SHOOTING.....	25
RECYCLING INFORMATION.....	26
APPENDIX.....	27
SPECIFICATIONS.....	27
DIMENSIONS.....	28
COMPLIANT TIMING.....	29

FOR YOUR SAFETY

SAFETY PRECAUTIONS

WARNING

STOP OPERATING THE MONITOR IF YOU ARE AWARE OF ANY PROBLEMS

If you notice any abnormal phenomena such as smoke, strange sounds or fumes, unplug the monitor and contact your dealer or iiyama service center immediately. Further use may be dangerous and can cause fire or electric shock.

NEVER REMOVE THE CABINET

High voltage circuits are inside the monitor. Removing the cabinet may expose you to the danger of fire or electric shock.

DO NOT PUT ANY OBJECT INTO THE MONITOR

Do not put any solid objects or liquids such as water into the monitor. In case of an accident, unplug your monitor immediately and contact your dealer or iiyama service center. Using the monitor with any object inside may cause fire, electric shock or damage.

INSTALL THE MONITOR ON A FLAT, STABLE SURFACE

The monitor may cause an injury if it falls or is dropped.

DO NOT USE THE MONITOR NEAR WATER

Do not use where water may be splashed or spilt onto the monitor as it may cause fire or electric shock.

OPERATE UNDER THE SPECIFIED POWER SUPPLY

Be sure to operate the monitor only with the specified power supply. Use of an incorrect voltage will cause malfunction and may cause fire or electric shock.

PROTECT THE CABLES

Do not pull or bend the power cable and signal cable. Do not place the monitor or any other heavy objects on the cables. If damaged, the cables may cause fire or electric shock.

ADVERSE WEATHER CONDITIONS

It is advisable not to operate the monitor during a heavy thunder storm as the continual breaks in power may cause malfunction. It is also advised not to touch the plug in these circumstances as it may cause electric shock.

CAUTION

INSTALLATION LOCATION

Do not install the monitor where sudden temperature changes may occur, or in humid, dusty or smoky areas as it may cause fire, electric shock or damage. You should also avoid areas where the sun shines directly on the monitor.

DO NOT PLACE THE MONITOR IN A HAZARDOUS POSITION

The monitor may topple and cause injury if not suitably located. Please also ensure that you do not place any heavy objects on the monitor, and that all cables are routed such that children may not pull the cables and possibly cause injury.

MAINTAIN GOOD VENTILATION

Ventilation slots are provided to keep the monitor from overheating. Covering the slots may cause fire. To allow adequate air circulation, place the monitor at least 10 cm (or 4 inches) from any walls. Do not remove the tilt stand when operating the monitor. Ventilation slots on the back of the cabinet will be blocked and the monitor may overheat if the stand is removed. This may cause fire or damage. Operating the monitor on its back, side, upside down or on a carpet or any other soft material may also cause damage.

DISCONNECT THE CABLES WHEN YOU MOVE THE MONITOR

When you move the monitor, turn off the power switch, unplug the monitor and be sure the signal cable is disconnected. If you do not disconnect them, it may cause fire or electric shock.

UNPLUG THE MONITOR

If the monitor is not in use for a long period of time it is recommended that it is left unplugged to avoid accidents.

HOLD THE PLUG WHEN DISCONNECTING

To disconnect the power cable or signal cable, always pull it by the plug. Never pull on the cable itself as this may cause fire or electric shock.

DO NOT TOUCH THE PLUG WITH WET HANDS

Pulling or inserting the plug with wet hands may cause electric shock.

WHEN YOU INSTALL THE MONITOR ON YOUR COMPUTER

Be sure the computer is strong enough to hold the weight of the monitor, otherwise, you may damage your computer.

CAREFUL! PROTECT YOUR HANDS AND FINGERS

- Be careful not to hurt your fingers or hands when you change the height or the angle.
- Injury can occur if care is not taken to avoid finger contact with the displays base when adjusting the height.

REMARK FOR 24/7 USAGE

This product is not specifically designed for 24/7 usage in all environments.

OTHERS

ERGONOMIC RECOMMENDATIONS

To eliminate eye fatigue, do not operate the monitor against a bright background or in a dark room. For optimal viewing comfort, the monitor should be just below eye level and 40-60 cm (16-24 inches) away from your eyes. When using the monitor over a prolonged time, a ten minute break every hour is recommended as looking at the screen continuously can cause eye strain.

SPECIAL NOTES ON LCD MONITORS

The following symptoms are normal with LCD monitors and do not indicate a problem.

- NOTE**
- When you first turn on the LCD monitor, the picture may not fit in the display area because of the type of computer that is used. In this case, adjust the picture position to the correct position.
 - You may find slightly uneven brightness on the screen depending on the desktop pattern you use.
 - Due to the nature of the LCD screen, an afterimage of the previous screen may remain after switching the image, when the same image is displayed for hours. In this case, the screen can be recovered slowly by changing the image or turning off the Power Switch for some hours.

CUSTOMER SERVICE

- NOTE**
- If you have to return your unit for service and the original packaging has been discarded, please contact your dealer or iiyama service center for advice or replacement packaging.

CLEANING

- WARNING**
- If you drop any materials or liquids such as water into the monitor when cleaning, unplug the power cable immediately and contact your dealer or iiyama service center.

- CAUTION**
- For safety reasons, turn off the power switch and unplug the monitor before you clean it.

- NOTE**
- To protect the LCD panel, do not scratch or rub the screen with a hard object.
 - Never use any of the following strong solvents. These will damage the cabinet and the LCD screen.

Thinner	Spray-type cleaner
Benzine	Wax
Abrasive cleaner	Acid or Alkaline solvent

- Touching the cabinet with any product made from rubber or plastic for a long time may cause degeneration or loss of paint on the cabinet.

CABINET Stains can be removed with a cloth lightly moistened with a mild detergent solvent. Then wipe the cabinet with a soft dry cloth.

LCD Periodic cleaning with a soft dry cloth is recommended.

SCREEN Don't use tissue paper etc. because these will damage the LCD screen.

BEFORE YOU OPERATE THE MONITOR

FEATURES

- ◆ Supports Resolutions up to 3840 × 2160
- ◆ High Contrast 1000:1 (Typical), Adv. Contrast Function Available / Brightness 300cd/m² (Typical) / Quick Response Time 5ms (Typical), 1ms (Gray to Gray)
- ◆ Supports AMD Radeon FreeSync™ technology
- ◆ Blue Light Reducer
- ◆ Digital Character Smoothing
- ◆ Stereo Speakers
2 × 3W Stereo Speakers
- ◆ Power Management (VESA DPMS Compliant)
- ◆ VESA Mounting Standard (100mm×100mm) Compliant
- ◆ Keyhole for Security Lock

CHECKING THE CONTENTS OF THE PACKAGE

The following accessories are included in your package. Check to see if they are enclosed with the monitor. If anything is missing or damaged, please contact your local iiyama dealer or regional iiyama office.

- | | | |
|---------------------|---------------------------------|---------------------|
| ■ Power Cable* | ■ HDMI Cable (1pc) | ■ DisplayPort Cable |
| ■ mDP-DP Cable | ■ USB Cable | ■ Audio Cable |
| ■ Stand Base | ■ Screw for stand fixing (3pcs) | ■ Safety Guide |
| ■ Quick Start Guide | | |

CAUTION

* The rating of the Power Cable enclosed in 120V area is 10A/125V. If you are using a power supply higher than this rating, then a power cable with a rating of 10A/250V must be used. However, all guarantees and warranties are void for any problems or damage caused by a power cable not supplied by iiyama.
An approved power cord greater or equal to H05VVf, 3G, 0.75mm² must be used.

WALL MOUNTING

- WARNING**
- When you use with the wall mounting, in consideration of thickness of the mounting stage, tighten the M4 Screw with washer which "L" length is 7mm to fasten the monitor. Using the screw longer than this may cause electric shock or damage because it may contact with the electrical parts inside the monitor.
 - Please check if the wall or ceiling can support the weight of the monitor before mounting it.

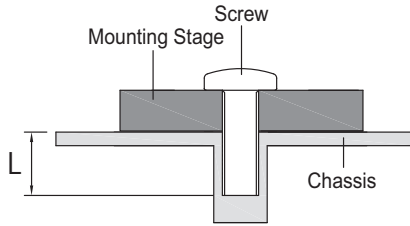

FITTING AND REMOVAL OF BASE

CAUTION

- Put the monitor on a stable surface. The monitor may cause injury or damage if it falls or is dropped.
- Do not give a strong impact to the monitor. It may cause damage.
- Unplug the monitor before removal or installation to avoid an electric shock or a damage.

<Installation>

- ① Put a piece of soft cloth on the table beforehand to prevent the monitor from being scratched. Lay the monitor flat on a table with front face down.
- ② Hold the monitor and install the Stand-Base.
- ③ Use the 'thumb screws' provided to secure the base to the monitor.

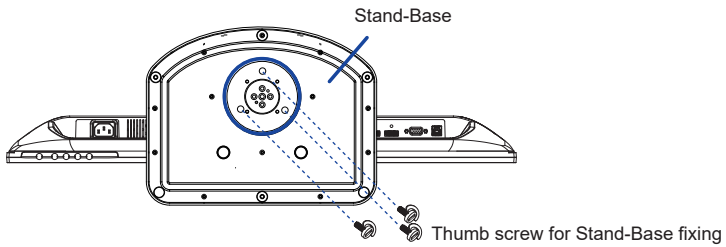

<Removal>

- ① Put a piece of soft cloth on the table beforehand to prevent the monitor from being scratched. Lay the monitor flat on a table with front face down.
- ② Remove the 'thumb screws' to remove the base from the monitor.

<Stopper>

Put the monitor on a flat surface. Press the stopper at the back of the stand while pushing the monitor from the top. Careful attention is required as the monitor is sprung loaded and the stand may expand quickly.

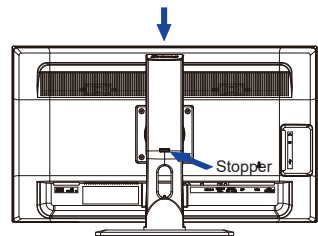

CONTROLS AND CONNECTORS

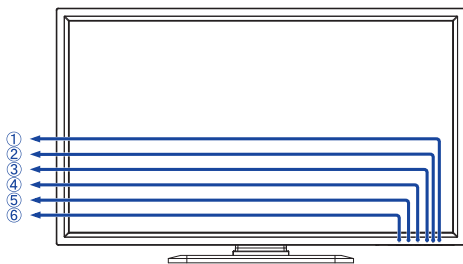

<Front>

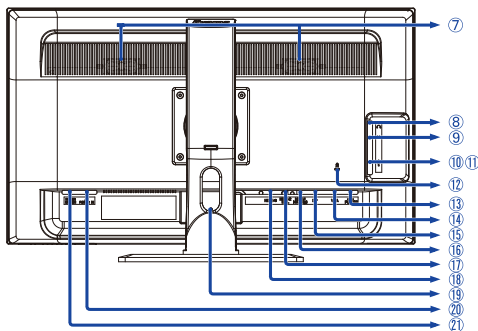

<Back>

① Power Switch ()

② Power Indicator

NOTE Blue: Normal operation
Orange: Power Management

③ Input / Select Button ()*

④ Scroll up / Audio Adjust Button ()*

⑤ Scroll down / i-Style Mode Button ()*

⑥ Menu Button ()

⑦ Speakers

⑧ Headphone Connector ()

⑨ Audio Connector ()

⑩ USB Downstream Connector ()

⑪ USB Downstream Connector ()

⑫ Keyhole for Security Lock

NOTE You can fasten a security lock and cable to prevent the monitor from being removed without your permission.

⑬ USB Upstream Connector ( PC USB)

⑭ VGA Connector (VGA)

⑮ DisplayPort Connector (DP)

⑯ HDMI Connector (HDMI-1 4K 60p)

⑰ HDMI Connector (HDMI-2)

⑱ HDMI Connector (HDMI-3)

⑲ Cable Hole

⑳ AC Connector ( : Alternating current) (AC POWER IN)

㉑ Main Power Switch (POWER SWITCH)

* You can skip the Menu items and display an adjustment scale directly.

CONNECTING YOUR MONITOR

- ① Ensure that both the computer and the monitor are switched off.
- ② Connect the computer to the monitor with the signal cable.
- ③ Connect the computer to the monitor with the USB Cable.
- ④ Connect the monitor to the audio equipment with the Audio Cable for computer when using the audio features.
- ⑤ Connect the Power Cable to the monitor first and then to the power source.
- ⑥ Turn on your monitor (Main Power Switch and Power Switch) and computer.

NOTE

- The signal cables used for connecting the computer and monitor may vary with the type of computer used. An incorrect connection may cause serious damage to both the monitor and the computer. The cable supplied with the monitor is for a standard connector. If a special cable is required please contact your local iiyama dealer or regional iiyama office.
- For connection to Macintosh computers, contact your local iiyama dealer or regional iiyama office for a suitable adaptor.
- Make sure you tighten the finger screws at each end of the signal cable.
- The Class I pluggable equipment Type A must be connected to protective earth.
- The socket-outlet shall be installed near the equipment and shall be easily accessible.
- Excessive sound pressure from ear-/headphones can cause hearing damage/hearing loss.

[Example of Connection]

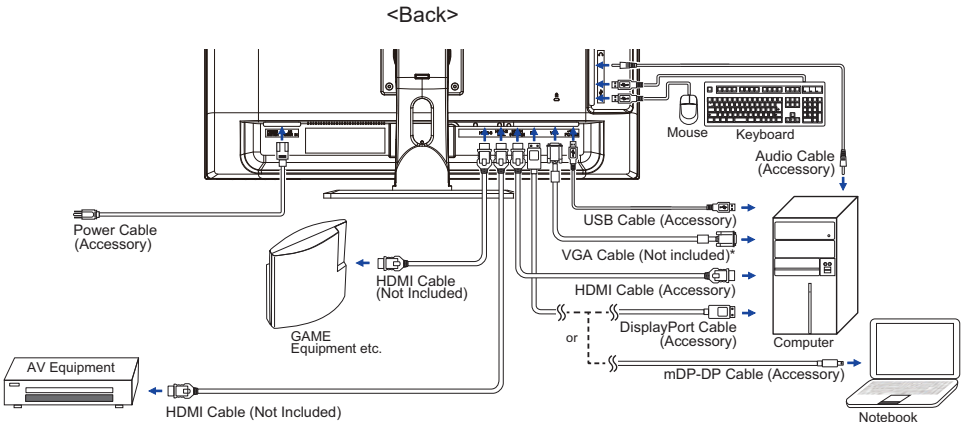

* VGA cable is not supplied with the monitor. If you use low quality VGA cable, it may cause a result of electro-magnetic interference. Please contact the iiyama Support Centre in your country if you wish to connect the monitor via the VGA input.

[Collect Cables]

Put the cables through the cable hole to bundle them.

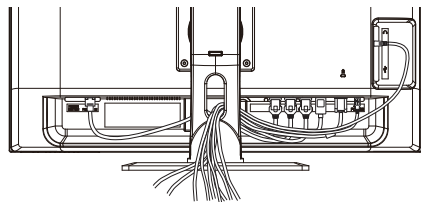

COMPUTER SETTING

■ Signal Timing

Change to the desired signal timing listed on page 29: COMPLIANT TIMING.

ADJUSTING THE HEIGHT AND THE VIEWING ANGLE

- For optimal viewing it is recommended to position yourself directly opposite to the full face of the monitor, then adjust the monitor's height and angle to your own preference.
- Hold the panel so that the monitor does not topple when you change the monitor's height or angle.
- You are able to adjust the monitor's height up to 130mm, angle up to 45° right and left, 17° upward.

NOTE

- Do not touch the LCD screen when you change the height or the angle. It may cause damage or break the LCD screen.
- Careful attention is required not to pinch your fingers or hands into the moving part of the stand when you change the height or the angle.
- Injury can occur if care is not taken to avoid finger contact with the displays base when adjusting the height.

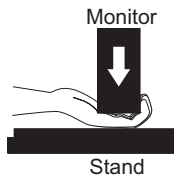
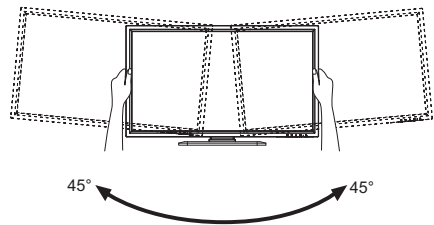
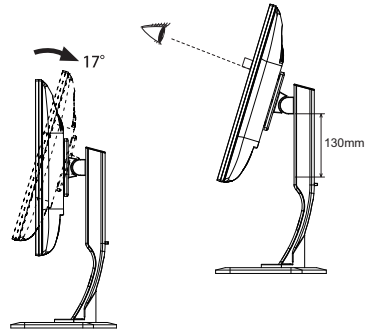

OPERATING THE MONITOR

The Auto Pow. Off function is enabled as default setting. Monitor will turn off automatically after 3 hours without any key operation.
If you prefer to use the monitor over 3 hours continuously, please disable The Auto Pow. Off function.

To create the best picture, your iiyama LCD monitor has been preset at the factory with the COMPLIANT TIMING shown on page 29. You are also able to adjust the picture by following the button operation shown below. For more detailed adjustments, see page 21 for SCREEN ADJUSTMENTS.

- Press the **1** Button to start the On Screen Display (OSD) feature. There are additional Menu items which can be switched by using the **▲ / ▼** Buttons.

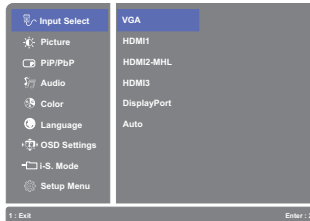

- Select the Menu item which contains the adjustment icon relating to the adjustment you want to make. Press the **2** Button. Then, use the **▲ / ▼** Buttons to highlight the desired adjustment icon.
- Press the **2** Button again. Use the **▲ / ▼** Buttons to make the appropriate adjustment or setting.
- Press the **1** Button to leave the menu, and the settings you just made would be automatically saved.

For example, to correct for vertical position, select Menu item of  (Setup Menu) and then press the **2** Button. Then, select Geometry by using the **▲ / ▼** Buttons and press the **2** Button. Then, select V. Position by using the **▲ / ▼** Buttons.

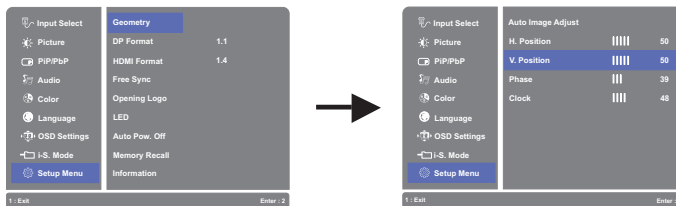

An adjustment page appears after you press the **2** Button. Then, use the **▲ / ▼** Buttons to change the vertical position settings. The vertical position should be changing accordingly while you are doing this.



Press the **1** Button lastly, it ends, all changes are saved in the memory.

NOTE

- When button operations are aborted during adjustment, On-Screen Display disappears when the time set for the OSD Time Out has passed. Also, the **1** Button can be used to return previous menu and turn off the On-Screen Display.
- Any changes are automatically saved in the memory when the On Screen Display disappears. Turning off the power should be avoided while using the Menu.
- Adjustments for Image H./V.Position, Clock and Phase are saved for each signal timing. Except for these adjustments, all other adjustments have only one setting which applies to all signal timings.

■ Disabled function matrix

		After enabled function						
		Adv. Contrast	ECO Mode	i-Style Mode	Blue Light Reducer	Brightness	Contrast	Overdrive
Function enable	Adv. Contrast	—	×	○	×	×	○	○
	ECO Mode	×	—	○	×	×	○	○
	i-Style Mode (Standard, Sports Game, FPS Game, Strategy Game, Text)	×	×	—	×	×	×	○
	Blue Light Reducer	×	×	○	—	○	○	○

○ : adjustable

× : disabled

ADJUSTMENT MENU CONTENTS



Input Select

Direct

Adjustment Item	Problem / Option	Button to Press
Input Select	VGA	Select the VGA input.
	HDMI1	Select the HDMI1 input.
	HDMI2	Select the HDMI2 input.
	HDMI3	Select the HDMI3 input.
	DisplayPort	Select the DisplayPor1 input.
	AUTO	Search for an available input source and select automatically.























NOTE

However it will automatically be selected when just one source is using.
In Power Management Mode input switching is disabled.
Input source is fixed, not selected automatically when VGA, HDMI1, HDMI2, HDMI3 and DisplayPort which are selected.

Direct

You can skip the Menu items and directly display an option setting screen by using the following button operations.

- Input Select: Press the  Button when the Menu is not displayed.

 Picture			
Adjustment Item	Problem / Option		Button to Press
Picture Format * ¹	Full Screen	Full screen display	
	Aspect Ratio	Expansion display of Aspect	
	Dot By Dot	Display the picture dot by dot.	
	17 inch	Display the picture as 17 inch screen (5 : 4)	
	19 inch	Display the picture as 19 inch screen (5 : 4)	
	19.5 inch	Display the picture as 19.5 inch screen (16 : 9)	
	21.5 inch	Display the picture as 21.5 inch screen (16 : 9)	
	23 inch	Display the picture as 23 inch screen (16 : 9)	
	24 inch	Display the picture as 24 inch screen (16 : 9)	
27 inch	Display the picture as 27 inch screen (16 : 9)		
Brightness * ^{2,3}	Too dark		
	Too bright		
Contrast * ³	Too dull		
	Too intense		
Black Tuner	From -5 to +5		
	You can adjust Dark shades.		
Sharpness	<p>You can change the picture quality from 0 to 100 (soft to sharp). Press the  Button to change the picture quality in numerical order. Press the  Button to change the picture quality in reverse numerical order. Adjust the picture quality at resolutions of less than 3840 x 2160. You can change the picture quality.</p>		
			
Overdrive * ³	Off / -2 / -1 / 0 / +1 / +2		
	<p>It will improve the gray level response time of the LCD panel. A higher level results in a faster response time.</p>		
Adv. Contrast * ^{1,3}	Off	Typical Contrast Ratio	
	On	Increased Contrast Ratio	
ECO Mode * ³	Off	Normal	
	1	Brightness of back-light is reduced.	
	2	Brightness of back-light is reduced more than 1.	
	3	Brightness of back-light is reduced more than 2.	
X-Res Technology	Off	Normal	
	Soft	Enhance the picture edge.	
	Middle	Enhance the picture edge more than the Soft option.	
	Hard	Enhance the picture edge more than the Middle option.	

*¹ Picture Format, Overdrive, Adv. Contrast are disabled when PiP/PbP Mode is activated.

*² Adjust the Brightness when you are using the monitor in a dark room and feel the screen is too bright.

*³ See page 11 for Disabled function matrix.

 PiP/PbP		
Adjustment Item	Problem / Option	Button to Press
PiP/PbP Mode *	Off	PiP/PbP Mode is turned off.
	PiP	Display the sub screen in the main screen.
	PbP	Divide display images in two
Sub Win Input	VGA	Select the VGA input.
	HDMI1	Select the HDMI1 input.
	HDMI2	Select the HDMI2 input.
	HDMI3	Select the HDMI3 input.
	DisplayPort	Select the DisplayPort input.
PiP Size	Small	Reduce the size of the Sub screen.
	Middle	Normal size
	Large	Increase the size of the Sub screen.
PiP Position	Top-Right	Move the sub screen to the top right corner.
	Top-Left	Move the sub screen to the top left corner.
	Bottom-Right	Move the sub screen to the bottom right corner.
	Bottom-Left	Move the sub screen to the bottom left corner.
Swap	Swaps the Main/Sub screens when PiP mode is active.	

* PiP = Picture In Picture

With this function, you can display two different pictures.

PbP = Picture By Picture

With this function, display images from two sources side by side.





Audio Direct	
Adjustment Item	Problem / Option Button to Press
Volume	Too soft ← ▲ Too loud → ▼
Mute Direct	Off Return the sound volume to the previous level. On Turn off the sound temporarily.
Audio Input *	Line-In Select the Line-In input.
	HDMI1 Select the HDMI1 input.
	HDMI2 Select the HDMI2 input.
	HDMI3 Select the HDMI3 input.
	DisplayPort Select the DisplayPort input.

* Suitable for HDMI/DisplayPort input only.

Direct

You can skip the Menu items and directly display an option setting screen by using the following button operations.

- Audio: Press the ▲ Button when the Menu is not displayed.
- Mute: Pressing and holding of the ▲ Button for about 2 seconds when the Menu is not displayed.
Mute and Unmute are switched as follows by pressing the ▲ Button successively.

 Color * ¹			
Adjustment Item	Problem / Option		Button to Press
Warm (5500K)	Reddish white		
Normal (6500k)	Greenish white		
Cool (9300k)	Bluish white		
User Color	Red	Too weak	 
	Green		
	Blue	Too strong	 
Blue Light Reducer * ² Direct	Off	Typical	
	1	Blue light is reduced.	
	2	Blue light is reduced more than Mode1.	
	3	Blue light is reduced more than Mode2.	
HDMI RGB Range * ³	Full Range	For full-range color scale signal	
	Limited Range	For limited color scale signal	

*¹ Functions other than Blue Light Reducer is disabled when Blue Light Reducer is activated.

*² See page 11 for Disabled function matrix.















*³ Only HDMI input.

Direct

You can skip the Menu items and directly display an option setting screen by using the following button operations.

- Blue Light Reducer: Pressing and holding of the  Button for about 2 seconds when the Menu is not displayed.

 Language				
Adjustment Item	Problem / Option			Button to Press
Language	English	English	Italiano	Italian
	Français	French	Русский	Russian
	Deutsch	German	日本語	Japanese
	Nederlands	Dutch	简体中文	Simplified Chinese
	Polski	Polish	繁體中文	Traditional Chinese
	Česky	Czech		

 OSD Setting		
Adjustment Item	Problem / Option	Button to Press
OSD H. Position	OSD is too left	 
	OSD is too right	 
OSD V. Position	OSD is too low	 
	OSD is too high	 
OSD Background	The background of OSD is made transparent. Off / 1 / 2 / 3 / 4	  
OSD Time Out	You can set the OSD display duration time. 5 / 10 / 20 / 30 / 60 seconds	  

 i-S. Mode			
Adjustment Item	Problem / Option		Button to Press
i-Style Mode	Direct	Off	i-Style Mode is turned Off.
		Standard	For general windows environment and monitor default setting.
		Sports Game	For Sports game environment.
		FPS Game	For FPS game environment.
		Strategy Game	For Strategy game environment.
		Text	For text editing and viewing in a word processing environment.
		User Mode 1	Applies customized monitor settings.
		User Mode 2	Applies customized monitor settings.
		User Mode 3	Applies customized monitor settings.
Save User Mode1/2/3	Save the settings of the screen adjustment.		
NOTE You can memorize your customized monitor settings. The following settings can be memorized: Contrast, Brightness, Overdrive, Adv. Contrast, ECO mode, Volume, Mute, Color, i-Style Mode, Sharpness, Black Tuner, Picture Format			

Direct

You can skip the Menu items and directly display an option setting screen by using the following button operations.

- i-Style Mode : Press the ▼ Button when the Menu is not displayed.



Setup Menu

Adjustment Item	Problem / Option		Button to Press	
Geometry *1	Auto Image Adjust *2 Direct		Adjust H. / V. Position, Clock and Phase automatically.	
	H. Position *3	Too left		
		Too right		
	V. Position *3	Too low		
		Too high		
Phase	To correct flickering text or lines			
Clock	Too narrow			
	Too wide			
DP Format *4	1.1	Standard		
	1.2	To be used when displaying 3840x2160 60Hz.		
HDMI1 Format *5	1.4	Standard		
	2.0	To be used when displaying 3840x2160 60Hz.		
FreeSync	On	Enable the Freesync function.		
	Off	The Freesync function is turned off.		
Opening Logo	On	iiyama Logo displayed when the monitor is turned on.		
	Off	iiyama Logo does not display when the monitor is turned on.		
LED	On	The Power Indicator is turned On.		
	Off	The Power Indicator is turned Off.		
NOTE Turn Off the Power Indicator when you are bothered by the light.				
Auto Pow. Off	On	Enable the Auto Pow. Off function.		
	Off	Auto Pow. Off function is turned Off.		
NOTE The Auto Pow. Off function is enabled as default setting. Monitor will turn off automatically after 3 hours without any key operation. If you prefer to use the monitor over 3 hours continuously, please disable The Auto Pow. Off function.				
Memory Recall	Yes	Factory-preset data is restored.		
	No	Return to Menu.		

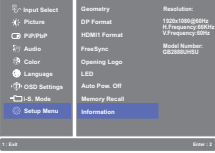
 Setup Menu		
Adjustment Item	Problem / Option	Button to Press
Information	Displays information regarding the current input signal coming from the graphic card in your computer. <Example> 	NOTE See your graphic card user guide for more information about changing the resolution and refresh.

*1 Only Analog Input.

*2 For best results, use the Auto Image Adjust in conjunction with the adjustment pattern. See page 21 for SCREEN ADJUSTMENTS.

*3 See page 21 for SCREEN ADJUSTMENTS.

*4 To display 3840 x 2160 at 60Hz, the DisplayPort setting must be enabled as 1.2, and the source graphic card must be capable of supporting 3840 x 2160 resolution at 60Hz.

*5 Only HDMI1 can support 3840 x 2160 60Hz.

To display 3840 x 2160 at 60Hz, the HDMI1 setting must be enabled as 2.0, and the source graphic card must be capable of supporting 3840 x 2160 resolution at 60Hz.

Direct

You can skip the Menu items and directly display an option setting screen by using the following button operations.

- Auto Image Adjust: Pressing and holding of the ▼ Button for about 2 seconds when the Menu is not displayed.

● Lock Mode

<OSD Menu>

1. The OSD lock will be activated by pressing the front buttons ① and ▲ for about 5 seconds. If you try to access the OSD by pressing any of the buttons ①, ▼, ▲ and ②, message "OSD Locked" will appear on the screen.
2. The OSD lock will be deactivated by pressing the front buttons ① and ▲ again for 5 seconds.

<Power Switch>

1. The power switch lock will be activated by pressing the front buttons ① and ▼ for 5 seconds. Locking the power switch means that won't be able to turn off the Monitor while the power switch is locked. If presses the power switch message "Power Button Locked" will appear on the screen.
2. The power switch lock will be deactivated by pressing the front buttons ① and ▼ again for about 5 seconds.

SCREEN ADJUSTMENTS

Adjust the image by following the procedure below to get the desired picture when selecting Analog input.

- The screen adjustments described in this manual are designed to set image position and minimize flicker or blur for the particular computer in use.
- Displayed text or lines will be blurred or irregular in thickness when the picture is stretched due to the screen enlargement process.
- It is preferable to adjust the image position and frequency with the monitor controls, rather than the computer software or utilities.
- Perform adjustments after a warm-up period of at least thirty minutes.
- Additional adjustments may be required after the Auto Image Adjust depending on the resolution or signal timing.
- The Auto Image Adjust may not work correctly when displaying the picture other than the screen adjustment pattern. In this case, manual adjustments are required.

There are two ways to adjust the screen. One way is automatic adjustment for Position, Clock and Phase. The other way is performing each adjustment manually.

Perform the Auto Image Adjust first when the monitor is connected to a new computer, or resolution is changed. If the screen has a flicker or blur, or the picture does not fit in the display area after performing the Auto Image Adjust, manual adjustments are required. Both adjustments should be made by using the screen adjustment pattern (Test.bmp) obtained via the Iiyama web site (<http://www.iiyama.com>).

Adjust the image by following the procedure below to get the desired picture.

This manual explains adjustment under Windows® OS.

- ① **Display the picture at the optimum resolution.**
- ② **Enter the Test.bmp (screen adjustment pattern) to wallpaper.**

NOTE

- Consult the appropriate documentation for doing this.
- Set the display position to center in the wallpaper setting dialogue box.

[Adjustment pattern]

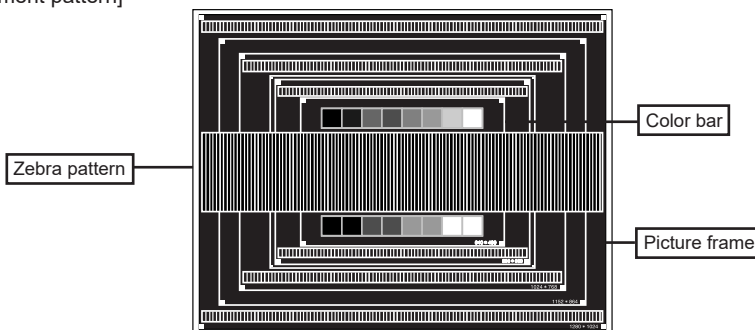

- ③ Pressing and holding of the ▼ Button for about 2 seconds. (Auto Image Adjust)
- ④ Adjust the image manually by following procedure below when the screen has a flicker or blur, or the picture does not fit in the display area after performing the Auto Image Adjust.
- ⑤ Adjust the V.Position so that the top and bottom of the picture frame will fit to the display area.

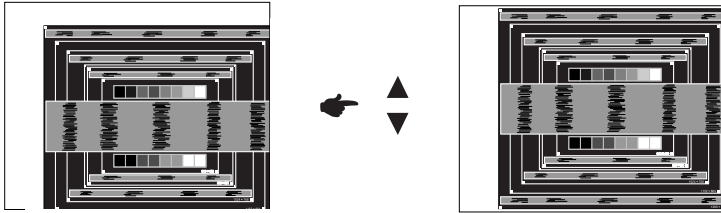

- ⑥ 1) Adjust the H.Position so that the left side of the picture frame will move to the left edge of the display area.

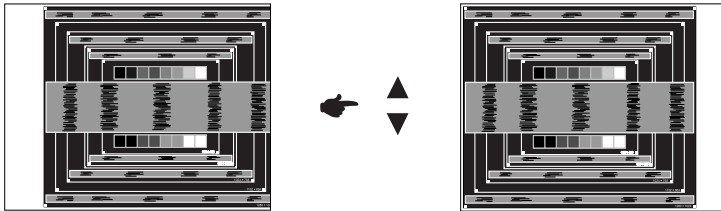

- 2) Stretch the right side of the picture frame to the right edge of the display area by adjusting the Clock.

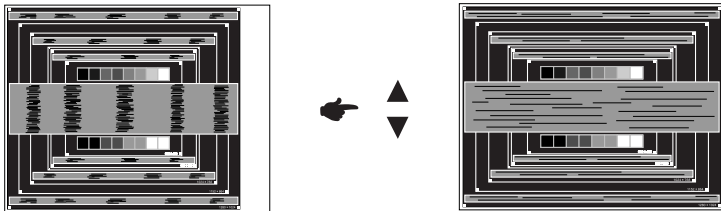
**NOTE**

- When the left side of the picture frame moves apart from the left edge of the display area during the Clock adjustment, adjust steps 1) and 2).
- Another way to make the Clock adjustment is to correct the vertical wavy lines in the zebra pattern.
- The picture may flicker during the Clock, H.Position and V.Position adjustment.
- In case the picture frame is bigger or smaller than the data display area after the Clock adjustment, repeat steps from ③.

⑦ Adjust the Phase to correct horizontal wavy noise, flicker or blur in the zebra pattern.

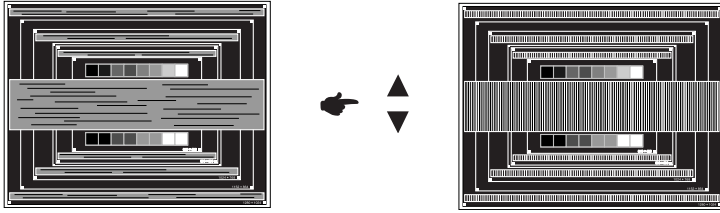

NOTE

- In case the strong flicker or blurs remain on a part of the screen, repeat steps ⑥ and ⑦ because the Clock may not be adjusted correctly. If the flicker or blurs still remain, set the refresh rate of computer to low (60Hz) and repeat steps from ③ again.
- Adjust the H.Position after the Phase adjustment if the horizontal position moves during the adjustment.

⑧ Adjust the Brightness and Color to get the desired picture after you complete the Clock and Phase adjustments.

Put back your favorite wallpaper.

POWER MANAGEMENT FEATURE

The power management feature of this product complies with power saving requirement of VESA DPMS. When activated, it automatically reduces unnecessary power consumption of the monitor when your computer is not in use.

To use the feature, the monitor needs to be connected to a VESA DPMS compliant computer. There is a power management step the monitor takes as described below. The power management function, including any timer settings is configured by the operating system. Check your operating system manual for information on how this can be configured.

■ Power Management Mode

When the H-sync signal / V-sync signal / H and V sync signals from the computer are off, the monitor enters into Power Management Mode which reduces the power consumption to less than 0.5W. The screen becomes dark, and the power indicator turns to orange. From Power Management Mode, the image reappears in several seconds when either the keyboard or the mouse are touched again.

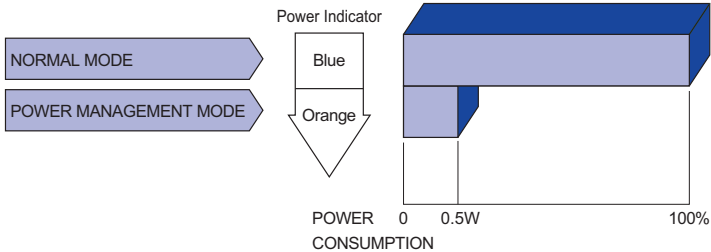

* USB peripherals and Audio equipment are not connected.

NOTE

- Even when using the power management mode, the monitor consumes electricity. Turn off the Power Switch whenever the monitor is not in use, during the night and weekends, to avoid unnecessary power consumption.
- It is possible that the video signal from the computer may be on while the H or V sync signal is missing. In this instance, the POWER MANAGEMENT feature may not work properly.

TROUBLE SHOOTING

If the monitor fails to operate correctly, please follow the steps below for a possible solution.

1. Perform the adjustments described in OPERATING THE MONITOR, depending on the problem you have. If the monitor does not get a picture, skip to 2.
2. Consult the following items if you cannot find an appropriate adjustment item in OPERATING THE MONITOR or if the problem persists.
3. If you are experiencing a problem which is not described below or you cannot correct the problem, discontinue using the monitor and contact your dealer or iiyama service center for further assistance.

Problem	Check
① The picture does not appear. (Power indicator does not light up.) (Power indicator is blue.) (Power indicator is orange.)	<input type="checkbox"/> The Power Cable is firmly seated in the socket. <input type="checkbox"/> The Power Switch is turned ON. <input type="checkbox"/> The AC socket is live. Please check with another piece of equipment. <input type="checkbox"/> If the blank screen saver is in active mode, touch the keyboard or the mouse. <input type="checkbox"/> Increase the Contrast and/or Brightness. <input type="checkbox"/> The computer is ON. <input type="checkbox"/> The Signal Cable is properly connected. <input type="checkbox"/> The signal timing of the computer is within the specification of the monitor. <input type="checkbox"/> If the monitor is in power management mode, touch the keyboard or the mouse. <input type="checkbox"/> The computer is ON. <input type="checkbox"/> The Signal Cable is properly connected. <input type="checkbox"/> The signal timing of the computer is within the specification of the monitor.
② The screen is not synchronized.	<input type="checkbox"/> The Signal Cable is properly connected. <input type="checkbox"/> The signal timing of the computer is within the specification of the monitor. <input type="checkbox"/> The video output level of the computer is within the specification of the monitor.
③ The screen position is not in the center.	<input type="checkbox"/> The signal timing of the computer is within the specification of the monitor.
④ The screen is too bright or too dark.	<input type="checkbox"/> The video output level of the computer is within the specification of the monitor.
⑤ The screen is shaking.	<input type="checkbox"/> The power voltage is within the specification of the monitor. <input type="checkbox"/> The signal timing of the computer is within the specification of the monitor.

Problem**Check**

- | | |
|---------------------------------------|--|
| ⑥ No sound. | <input type="checkbox"/> The audio equipment (computer etc.) is ON. |
| | <input type="checkbox"/> The Audio Cable is properly connected. |
| | <input type="checkbox"/> The Volume is turned up. |
| | <input type="checkbox"/> The Mute is OFF. |
| | <input type="checkbox"/> The audio output level of the audio equipment is within the specification of the monitor. |
| ⑦ The sound is too loud or too quiet. | <input type="checkbox"/> The audio output level of the audio equipment is within the specification of the monitor. |
| ⑧ A strange noise is heard. | <input type="checkbox"/> The Audio Cable is properly connected. |

RECYCLING INFORMATION

For better environment protection please don't dispose your monitor.
Please visit our web site: www.iiyama.com for monitor recycling.

APPENDIX

Design and specifications are subject to change without prior notice.

SPECIFICATIONS

Size Category	28"	
LCD Panel	Panel technology	TN
	Size	Diagonal: 28" (71cm)
	Pixel pitch	0.162mm H × 0.158mm V
	Brightness	300cd/m ² (Typical)
	Contrast ratio	1000 : 1 (Typical), Adv. Contrast Function Available
	Viewable angle	Right / Left : 85° each, Up / Down: 80° each (Typical)
	Response time	5ms (Typical), 1ms (Gray to Gray)
Display Colors	Approx. 1.07 Billion	
Sync Frequency	VGA: Horizontal: 30.0-80.0kHz, Vertical: 55-75Hz HDMI1: Horizontal: 30.0-135.0kHz, Vertical: 24-30,55-75Hz HDMI2: Horizontal: 30.0-90.0kHz, Vertical: 24-30,55-75Hz HDMI3: Horizontal: 30.0-90.0kHz, Vertical: 24-30,55-75Hz DisplayPort (without FreeSync): Horizontal: 30.0-135.0kHz, Vertical: 24-30,55-75Hz DisplayPort (with FreeSync): Horizontal: 30.0-135.0kHz, Vertical: 35-60Hz	
Native Resolution	3840 × 2160, 8.3 MegaPixels	
Supported max. resolution	VGA : 2048 × 1152 60Hz HDMI1 : 3840 × 2160 60Hz HDMI2 : 3840 × 2160 30Hz, 2560 × 1440 60Hz, 1920 × 2160 60Hz HDMI3 : 3840 × 2160 30Hz, 2560 × 1440 60Hz, 1920 × 2160 60Hz DisplayPort: 3840 × 2160 60Hz	
Input Connector	VGA, HDMI x3, DisplayPort	
Plug & Play	VESA DDC2B™	
Input Sync Signal	Separate sync: TTL, Positive or Negative	
Input Video Signal	Analog: 0.7Vp-p (Standard), 75Ω, Positive Digital: HDMI, DisplayPort	
USB Standard	USB3.0	
Number of USB Ports	1 Upstream : Series B	
Connector shape	2 Downstream : Series A	
Input Audio Connector	ø 3.5mm mini jack (Stereo)	
Input Audio Signal	1.0Vrms maximum	
Headphone Connector	ø 3.5mm mini jack (Stereo)	
Speakers	3W × 2 (Stereo speakers)	
Maximum Screen Size	620.9mm W × 341.3mm H / 24.4" W × 13.4" H	
Power Source	100-240VAC, 50/60Hz, 1.0A	
Power Consumption*	42W typical, Power management mode: 0.5W maximum Energy Efficiency Class: B	
Dimensions / Net Weight	663.0 × 413.5 - 543.5 × 230.0mm / 26.1 × 16.3 - 21.4 × 9.1" (W×H×D) 7.7kg / 16.9lbs	
Tilt Angle	Upward: 17°, Left/Right: 45° each	

Environmental Considerations	Operating: Temperature	5 to 35°C / 41 to 95°F
	Humidity	10 to 80% (No condensation)
Approvals	Storage: Temperature	-20 to 60°C / -4 to 140°F
	Humidity	5 to 85% (No condensation)

NOTE * USB and Audio equipment are not connected.

DIMENSIONS

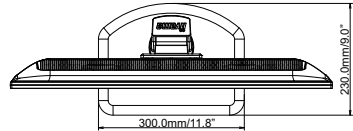
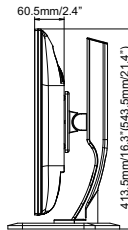
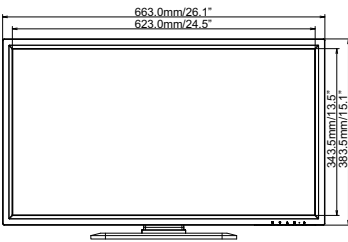

() : Maximum adjustment range

COMPLIANT TIMING

Video Mode	Horizontal Frequency	Vertical Frequency	Dot Clock
640 × 480	31.469kHz	59.940Hz	25.175MHz
	37.500kHz	75.000Hz	31.500MHz
	37.861kHz	72.809Hz	31.500MHz
800 × 600	35.156kHz	56.250Hz	36.000MHz
	37.879kHz	60.317Hz	40.000MHz
	46.875kHz	75.000Hz	49.500MHz
1024 × 768	48.363kHz	60.004Hz	65.000MHz
	56.476kHz	70.069Hz	75.000MHz
	60.023kHz	75.029Hz	78.750MHz
1280 × 1024	63.981kHz	60.020Hz	108.000MHz
	79.976kHz	75.025Hz	135.000MHz
1440 × 900	55.935kHz	59.887Hz	106.500MHz
	70.635kHz	74.984Hz	136.750MHz
1680 × 1050	65.290kHz	60.000Hz	146.250MHz
1920 × 1080	66.590kHz	59.930Hz	138.500MHz
2048 × 1152	71.584kHz	60.000Hz	197.000MHz
2560 × 1440	88.787kHz	59.951Hz	241.500MHz
3840 × 2160	67.430kHz	29.970Hz	296.700MHz
	133.313kHz	59.997Hz	533.250MHz
1920 × 2160	135.000kHz	60.000Hz	297.000MHz

NOTE *1 HDMI1, HDMI2, HDMI3 and DisplayPort input only.

*2 HDMI1 and DisplayPort input only.

*3 Recommended to use on PbP mode.